



SOBA

Faretto ad incasso 12V, cardanico orientabile su due assi di 360° rispetto all'asse verticale e di ±40° rispetto all'asse orizzontale.

Attacco GU5,3 che consente di montare lampadina LED.

Struttura in alluminio tornito spazzolato. Disponibile nella versione a uno o due elementi.

Necessita di alimentatore da installare in remoto (pag.697-701).



plafone pag. 129



6501-1



6501-2

Codice		Potenza	Dimensioni mm
6501-1	GU5,3	1x50W max	87 x 87 x 40
6501-2	GU5,3	2x50W max	174 x 87 x 40

  IP20

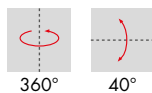
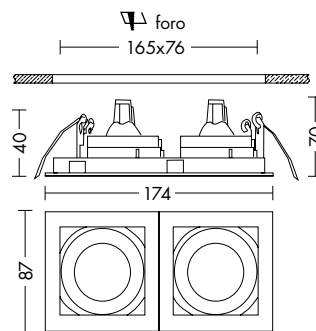
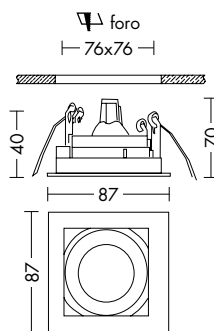

Finiture

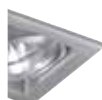

Alluminio spazzolato

Accessori

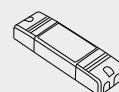

alimentatore 12V
pag.697-701

SOBA

Apparecchio cardanico da soffitto orientabile su 2 assi di 355° rispetto all'asse verticale e di $\pm 180^\circ$ rispetto all'asse orizzontale con con attacco GU10 che consente di montare lampadina LED.

Struttura in alluminio spazzolato.

Proposto nella versione ad uno o due elementi.



incasso pag. 59

 IP20

Codice		Potenza	Dimensioni mm
6502-1	GU10	1x40W max	82 x 82 x 95
6502-2	GU10	2x40W max	165 x 82 x 95

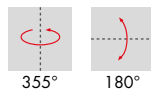

355°

180°

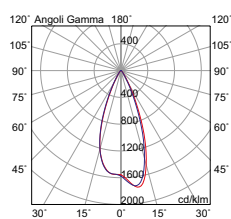
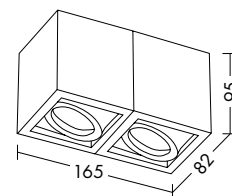
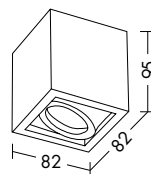

Finiture



Alluminio spazzolato