



# OLIVER

Apparecchio a parete per esterno (IP55) con struttura in pressofusione di alluminio verniciato a polveri resistente a raggi UV e corrosione, e diffusore in policarbonato opale.

Attacco E27 che consente di montare lampadina LED.

Disponibile in tre finiture (bianco, grigio, antracite).



terra pag. 608



Codice

**A.10067-XX**



E27

Potenza

1x75W max

⊕ IP55

Dimensioni mm

110x250x103

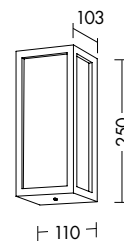

## Finiture



B



GR



AN

## Accessori



compatibile con lampadine LED/smart pag.710



connessione IP68 pag.718

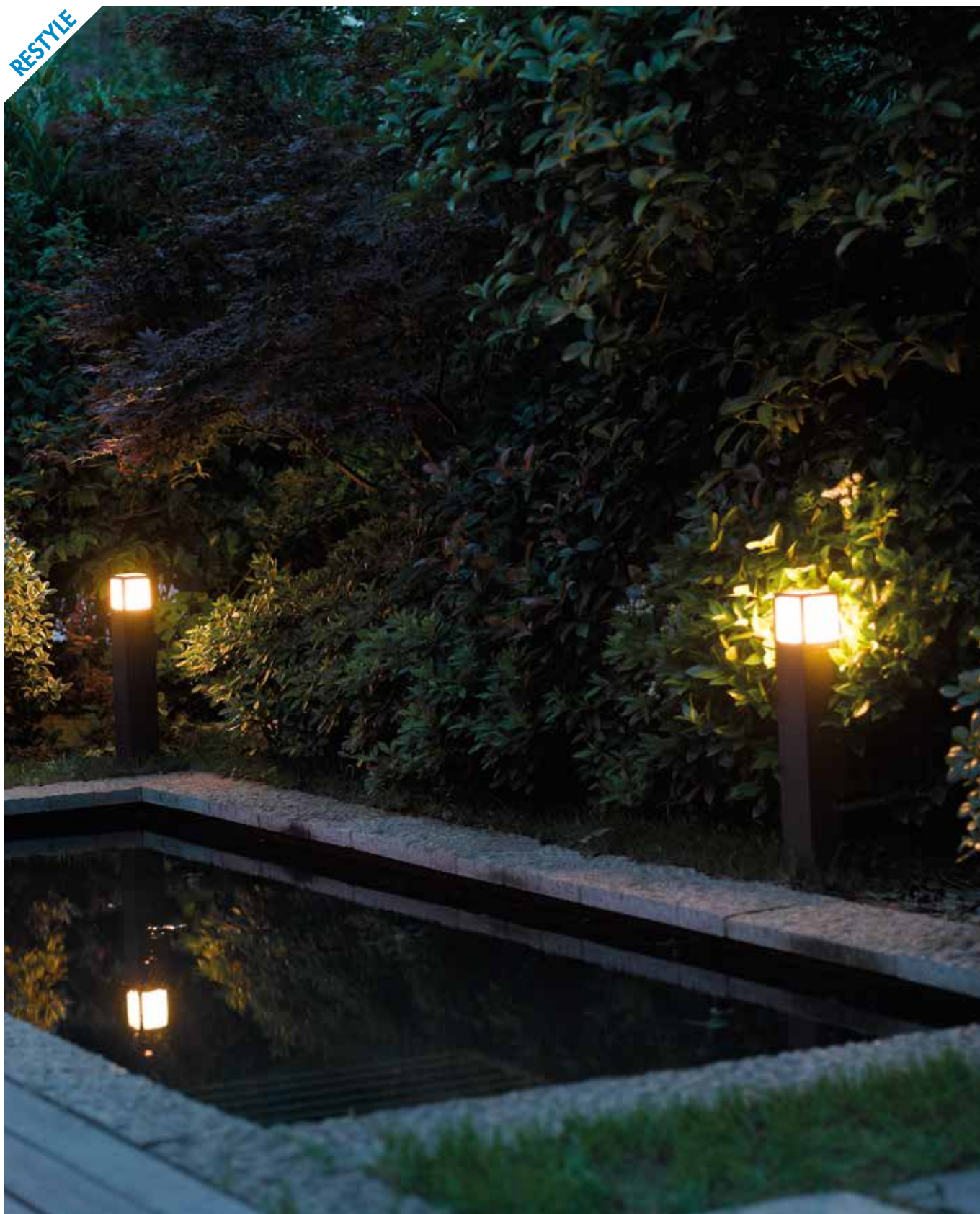

## OLIVER

Paletto da terra per esterno (IP54) a LED o con attacco E27 che consente di montare lampadine a LED. Struttura in pressofusione di alluminio, verniciato con polveri poliestere ad elevata resistenza ai raggi ultravioletti e alla corrosione.





Diffusore in policarbonato per un effetto di luce diffusa. Disponibile in due altezze, due finiture (antracite e grigio), per la versione LED in due temperature colore (3000K e 4000K) e con alimentatore integrato.

Disponibili giunti certificati IP68 per la realizzazione di connessioni elettriche, sicure, con barriera anticondensa (pag.718).



parete pag.587



 270°
  CRI≥80
  IP54

Codice	CCT	Flusso lm	Potenza	Dimensioni mm
<b>OLI001XX</b>	3000K	1340	15W	108 x 108 x 265
<b>OLI003XX</b>	4000K	1407	15W	108 x 108 x 265
<b>OLI002XX</b>	3000K	1340	15W	108 x 108 x 650
<b>OLI004XX</b>	4000K	1407	15W	108 x 108 x 650

Codice		Potenza	Dimensioni mm
<b>NEW OLI005XX</b>	E27	1 x 20W LED max	108 x 108 x 265
<b>OLI006XX</b>	E27	1 x 20W LED max	108 x 108 x 650

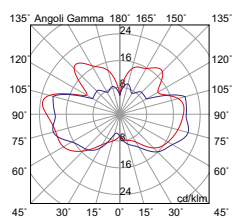
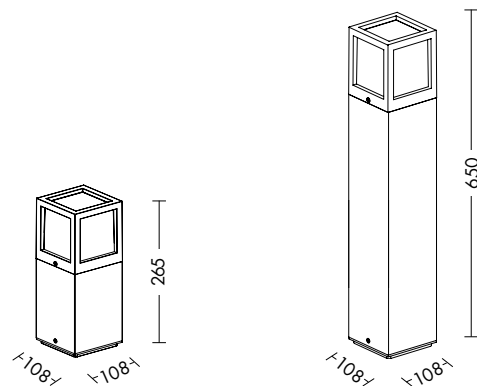
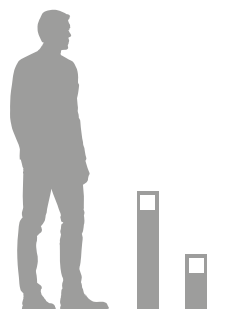

#### Finiture



GR



AN

#### Accessori



connessione IP68 pag.718