



DON

Proiettore LED per esterno (IP65) applicabile a soffitto o a parete. Struttura in pressofusione di alluminio verniciato nero resistente agli impatti e urti grazie ad un grado di protezione IK08.





Orientabile su unico asse di 340° e diffusore in vetro trasparente.

Adatto per illuminare ampie aree, per l'alto livello di resa luminosa.

Disponibile in diverse misure e relative potenze, due temperature colore (3000K e 4000K) e nella versione con sensore a raggi infrarossi di presenza per le potenze da 10W e 30W (rilevazione movimento fino a 12mt. di distanza con periodo di accensione regolabile tra 5 secondi e 5 minuti).

Alimentatore LED integrato.

Disponibili giunti certificati IP68 per la realizzazione delle connessioni elettriche, sicure, durevoli e con barriera anticondensa (pag.718).





IP65 IK08

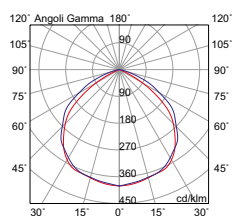
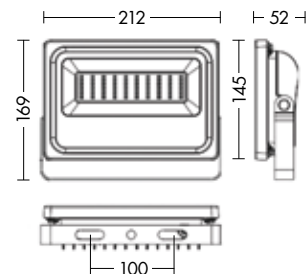
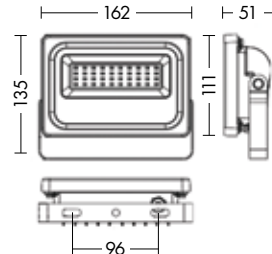
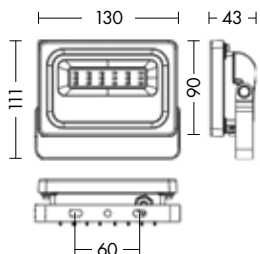

Codice	CCT	Flusso lm	Potenza	Dimensioni mm
DON001	3000K	1140	10W	130 x 90 x 43
DON002	4000K	1200	10W	130 x 90 x 43
DON003	3000K	2280	20W	162 x 111 x 51
DON004	4000K	2400	20W	162 x 111 x 51
DON005	3000K	3420	30W	212 x 145 x 52
DON006	4000K	3600	30W	212 x 145 x 52



Finiture



Nero

Accessori



connessione IP68 pag.718



Codice	CCT	Flusso lm	Potenza	Dimensioni mm
DON007	3000K	5700	50W	277 x 190 x 61
DON008	4000K	6000	50W	277 x 190 x 61
DON009	3000K	11400	100W	372 x 256 x 83
DON010	4000K	12000	100W	372 x 256 x 83

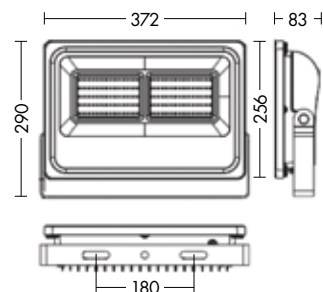
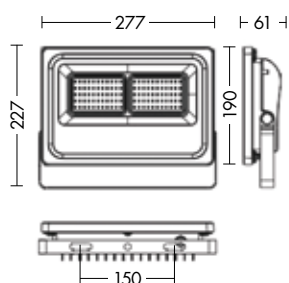

CON SENSORE DI PRESENZA



Codice	CCT	Flusso lm	Potenza	Dimensioni mm
DON011	3000K	1140	10W	130 x 90 x 43
DON012	4000K	1200	10W	130 x 90 x 43
DON013	3000K	3420	30W	212 x 145 x 52
DON014	4000K	3600	30W	212 x 145 x 52

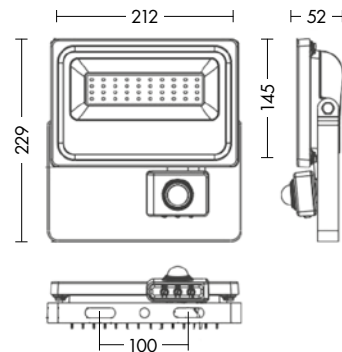
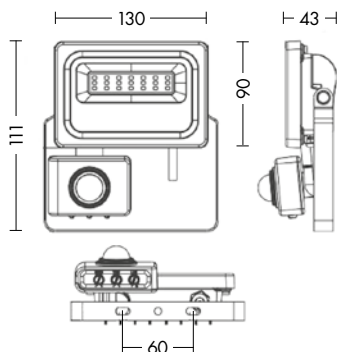

Sensore di presenza ad infrarossi.
 Rilevazione movimento fino a 12mt.
 Accensione regolabile tra 5 secondi e 5 minuti.

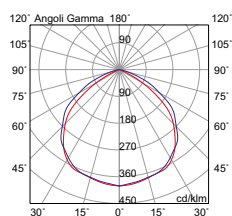

Finiture



Nero

Accessori



connessione IP68 pag.718