

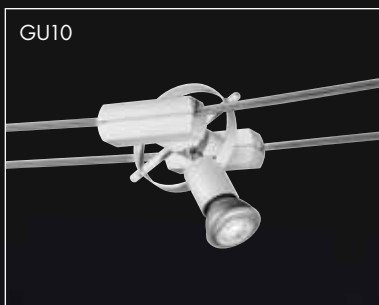

320 mm

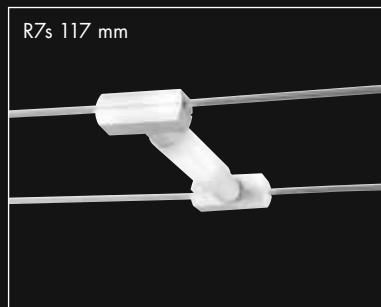

## CABLE

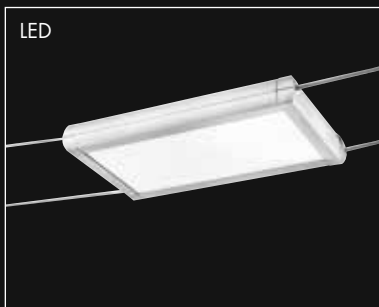

MADE IN  
MILANO

Sistema a tesata con coppia di cavi con interasse 320mm: permette di installare apparecchi con fonte luminosa con LED integrato o con attacco tradizionale (GU10, R7s, E27 che consentono di montare lampadina LED).

Corpi illuminanti, da posizionare secondo le esigenze di installazione, in estruso di alluminio (verniciato bianco opaco o grigio opaco) e diffusore in policarbonato.

Disponibili in versione luce diffusa, monoemissione o biemissione o a spot con corpo illuminante orientabile su due assi di  $\pm 35^\circ$  rispetto all'asse verticale e di  $\pm 90^\circ$  rispetto all'asse orizzontale. LED disponibile in due gradazioni (3000K e 4000K).

## MONOEMISSIONE LUCE DIRETTA









Codice	CCT	Flusso lm	Potenza	Dimensioni mm
<b>CAB109XX</b>	3000K	2660	23W	322 x 322 x 46
<b>CAB110XX</b>	4000K	2800	23W	322 x 322 x 46
<b>CAB111XX</b>	3000K	3420	25W	632 x 322 x 46
<b>CAB112XX</b>	4000K	3600	25W	632 x 322 x 46

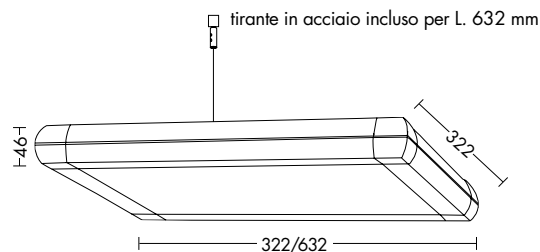
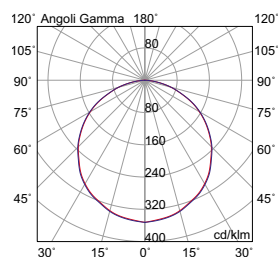

320 mm



## BIEMISSIONE







Codice	CCT	Flusso lm	Potenza	Dimensioni mm
<b>CAB113XX</b>	3000K	2660+1140	23W+8W	322 x 322 x 46
<b>CAB114XX</b>	4000K	2800+1200	23W+8W	322 x 322 x 46
<b>CAB115XX</b>	3000K	3420+2280	25W+16W	632 x 322 x 46
<b>CAB116XX</b>	4000K	3600+2400	25W+16W	632 x 322 x 46

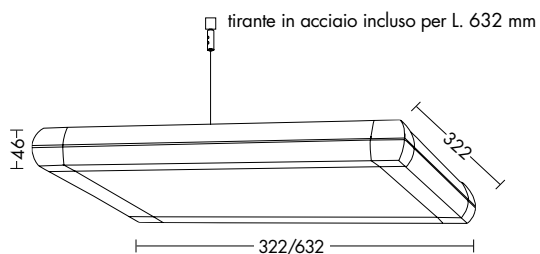
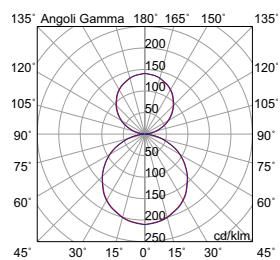

## Finiture



B



GR



Esclusivo sistema di aggancio rapido senza l'ausilio di utensili



Codice		Potenza	Dimensioni mm
<b>CAB201XX</b>	R7s 117mm	1x120W max	90 x 314 x 38

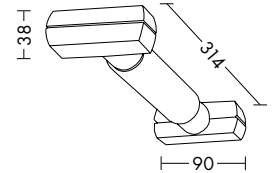

Codice		Potenza	Dimensioni mm
<b>CAB401XX</b>	GU10	1x50W max	90 x 314 x 140

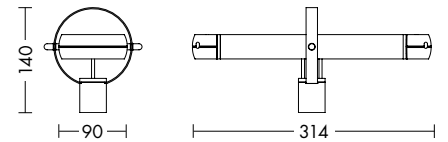
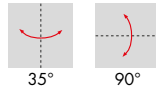

Codice		Potenza	Dimensioni mm
<b>CAB301XX</b>	E27	1x75W max	90 x 314 x 200

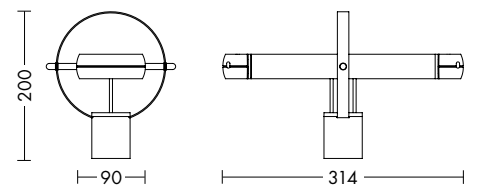
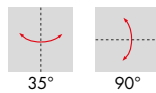

Finiture



B













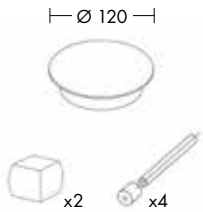

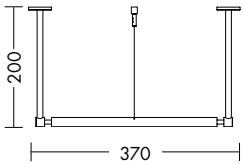
GR

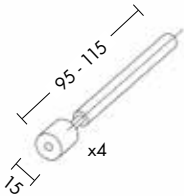

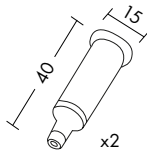
B

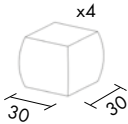

GR

	Codice	Finitura	Dimensioni	Descrizione
	<b>20305-B</b> <b>20305-GR</b>	bianco grigio		<b>Kit fissaggio e alimentazione</b> Kit di fissaggio installabile a parete o soffitto, composto da scatola di alimentazione, cavo e agganci. Lunghezza massima del cavo in dotazione (cavo a un conduttore) 1000mm.
	<b>CAB501</b>	cromo		<b>Sostegno tesata e distanziatore</b> Distanziatore in ottone cromato, per tendere i cavi da parete a soffitto o da soffitto a soffitto, altezza 200mm. Accessorio utilizzabile anche come sostegno.
	<b>20315</b>			<b>Kit fissaggio</b> Kit di fissaggio installabile a parete o soffitto con ganci (4 pezzi).
	<b>20310</b>			<b>Kit sostegno</b> Kit di sostegno per eliminare la flessione dei cavi in installazioni lunghe o con diversi apparecchi. Composto da fune in acciaio, agganci a soffitto e agganci di ancoraggio alla tesata. Lunghezza massima della fune in dotazione 1500mm.
	<b>20320-B</b> <b>20320-GR</b>	bianco grigio		<b>Kit connettori</b> Kit connettori per alimentare più linee, composto da cavo a un conduttore e coppia di connettori con ruba corrente.
	<b>C.73-15</b> (15 mt) <b>C.73-30</b> (30 mt) <b>C.73-50</b> (50 mt) <b>C.73-100</b> (100 mt)			<b>Cavo per doppia accensione</b> Cavo elettrico conduttore 2x1,5mm <sup>2</sup> e cavo d'acciaio di tenuta. Disponibile in matassa da 15, 30, 50 e 100 metri.
	<b>C.74-15</b> (15 mt) <b>C.74-30</b> (30 mt) <b>C.74-50</b> (50 mt) <b>C.74-100</b> (100 mt)			<b>Cavo per singola accensione</b> Cavo elettrico conduttore 1x1,5mm <sup>2</sup> e cavo d'acciaio di tenuta. Disponibile in matassa da 15, 30, 50 e 100 metri.